



# HOSHIZAKI

## CERTIFICATION



HACCP International



ISO9001

## FM-120KS-50-HC

### FLAKE ICE MAKER



## Key Features



NATURAL  
REFRIGERANTS

**Eco-Friendly  
Refrigerant**



**Easy for maintenance**  
Notify when parts should  
be replaced

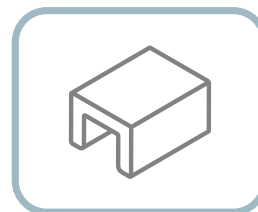

**Stainless Steel  
Exterior**

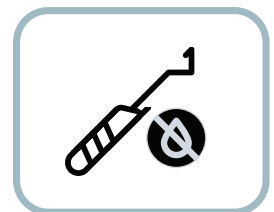

**Stainless Steel &  
Greaseless Auger**

Our Flake & Nugget Ice Makers belong to the true allrounders of the Hoshizaki product line-up. These powerful, durable and sustainable machines are highly popular across different market segments, such as in food preparation / processing, as well as in hotels, bars, restaurants and catering businesses.



# Dimensions & Specifications

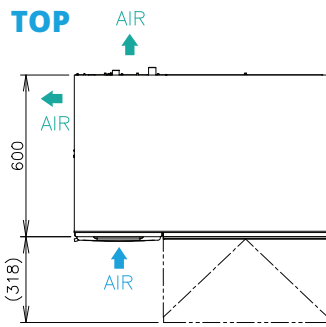

## ICE SHAPE FLAKE



## LEFT SIDE

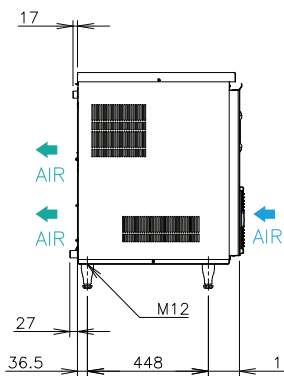

## FRONT

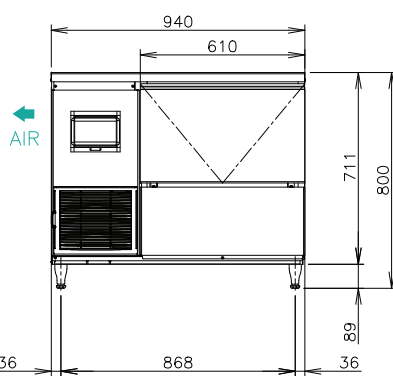

## RIGHT SIDE

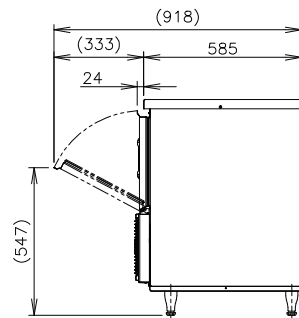

## BACK

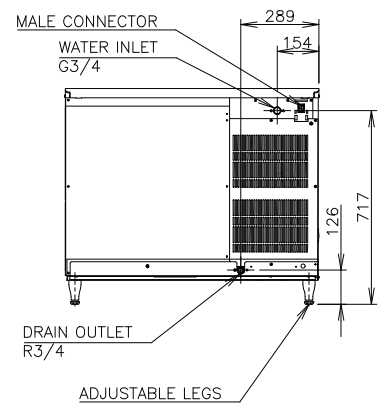

<b>MODEL</b>		<b>FM-120KS-50-HC</b>
<b>ICE SHAPE</b>		Flake Ice
<b>POWER SUPPLY</b>		1 Phase 220-240V 50Hz Capacity: 0.53kVA (2.2A)
<b>AMPERAGE</b>		2.2A Started: 8.8A
<b>ELECTRIC CONSUMPTION</b>		353W
<b>HEAT REJECTION</b>	(AT32°C / WT21°C)	820W
<b>ICE PRODUCTION PER 24H</b>	(AT10°C / WT10°C)	137kg
	(AT21°C / WT15°C)	119kg
	(AT32°C / WT21°C)	88kg
<b>STORAGE CAPACITY</b>		Approx. 57kg
<b>WATER CONSUMPTION PER 24H</b>	(AT32°C / WT21°C)	95L
<b>REFRIGERANT</b>		R290 / 85g
<b>OUTSIDE DIMENSIONS</b>		940mm(W) x 600mm(D) x 800( - 833)mm(H)
<b>PACKAGE</b>		Carton 1046mm(W) x 706mm(D) x 887mm(H)
<b>WEIGHT</b>		72kg (Gross 88kg)
<b>OPERATING CONDITIONS</b>		Ambient Temp:5-40°C, Water Supply Temp:5-35°C, Water Supply Pressure: 0.05-0.78MPa, Voltage Range: Rated Voltage±6%



# HOSHIZAKI

## HOSHIZAKI VIETNAM CORPORATION

168/14 Nguyen Gia Tri, Thanh My Tay Ward, Ho Chi Minh City  
Vietnam 760000

TEL +84 0 916 161 346 <https://hoshizaki-sea.com/>

